

ARTICLE NUMBER 1830-A6B050000002

MULTILINE E

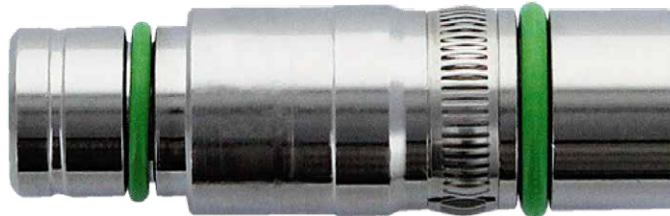

Circular connector, female

Insert - Plug type B

M12

5-pole

A-coded

shielded

fits to electrical insert
1830-A6B050000001

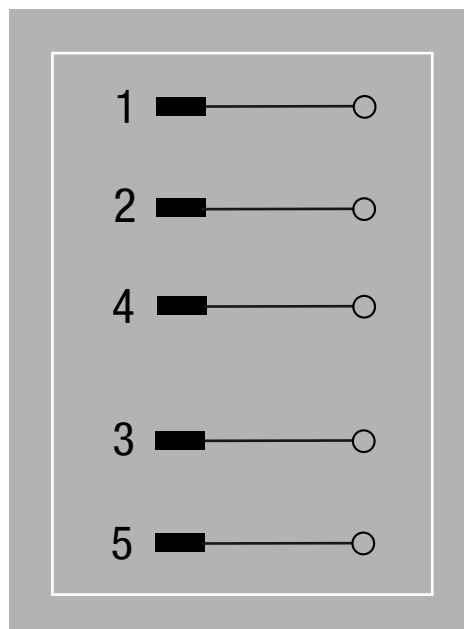

Male

Female

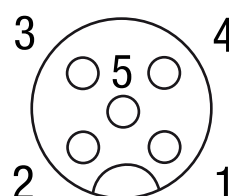
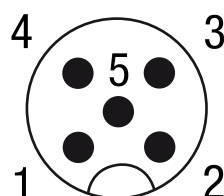

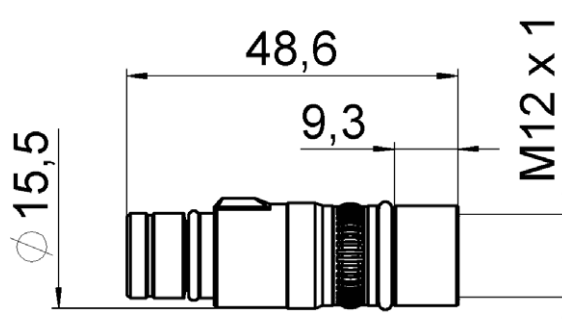

General data

Seal	FKM
Temperature range	-25 to +85 °C
Rated impuls voltage	1,5 kV
Mounting method	inserted, tightened

Technical data

Operating voltage	max. 49 V AC/DC
Operating current per contact	max. 4 A
Number of poles	5
Coding	A-coded
Locking of ports	screw thread (M12×1 mm) recommended torque 0,6 Nm, self-securing
Compression gland	M12
Protection	IP65 and IP67 when inserted and tightened (EN 60529)
Material group	Category I according to IEC 60664-1
Material (base body)	nickel-plated brass
Material (contact)	copper alloy
Material (contact surface)	Au

Commercial data

Minimum order quantity	1
Country of origin	DE